



NRS International

NRS INTERNATIONAL AND LOSBERGER PROUDLY PRESENT

TT200

TRANSITIONAL TENT



NRS International

NRS International is an industry leader in developing, manufacturing and supplying core relief items for the humanitarian aid and public health sectors.

JALOZAI REFUGEE CAMP, PAKISTAN



Losberger RDS is an international system integrator of temporary space solutions for accommodation and field camps, medical posts and mobile hospitals, storage and warehousing, maintenance and workshops shelters.



UN MINUSMA, CAMP GAO, MALI

LOOKING BACK

- After start of the Transitional Shelter Project, first prototype demonstrated in 2009.
- Pre-production sample of the TS200 Transitional Shelter demonstrated at DFID Kemble test days, November 2010.
- TS200 samples tested by MSF France, Caritas Switzerland and University of Cambridge.



RESULTS

- Testing results TS200.
- Experience and knowledge gathered by Shelter Centre.
- Draft of Transitional Shelter Procurement Specification, July 2013.



TT 200 Transitional Tent

- Based on draft Transitional Shelter Procurement Specifications.
- Added features based on NRS and Losberger knowhow.
- Result: TT 200

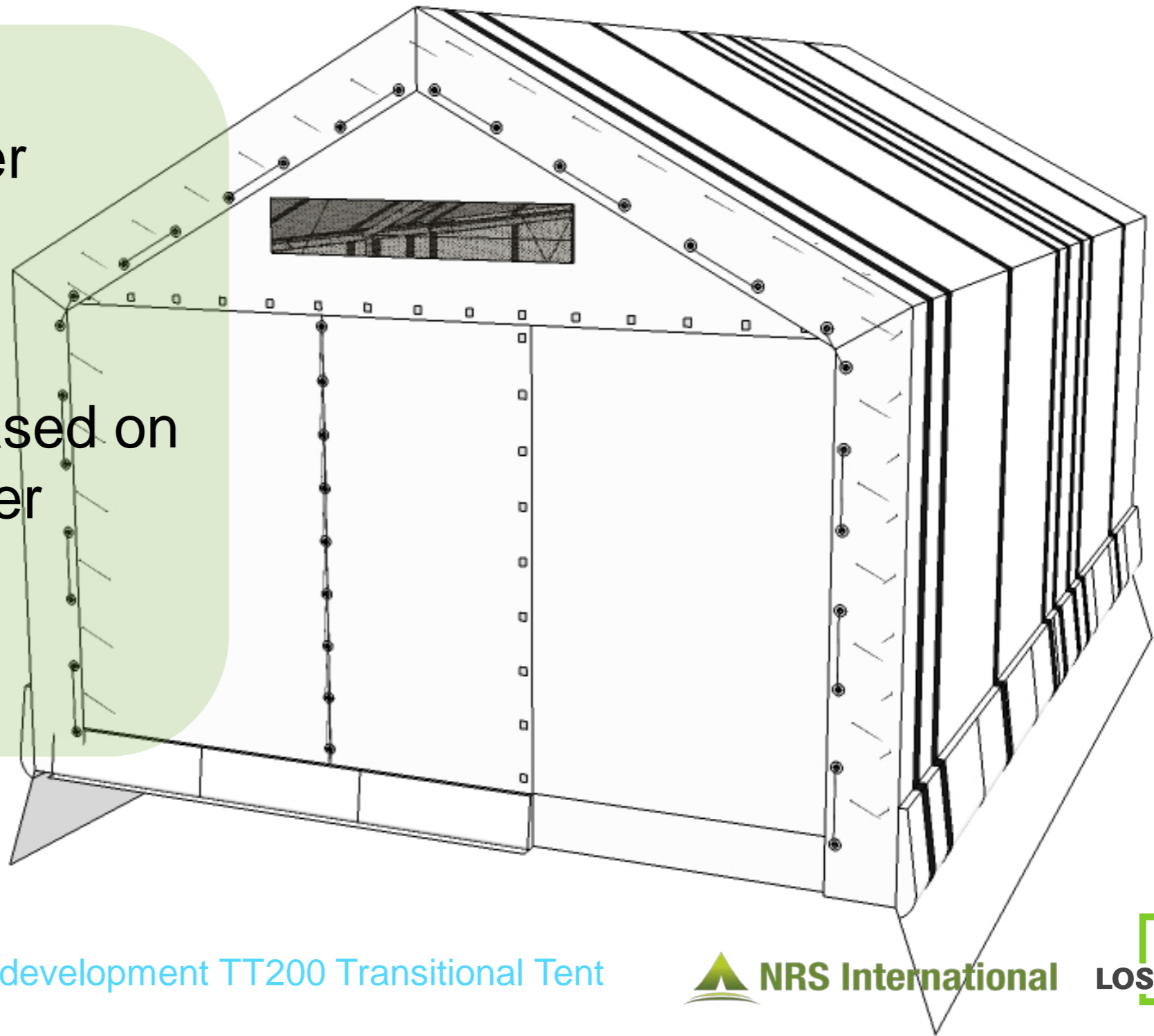

TT 200 Transitional Tent

Frame

- Stability is guaranteed independent of anchoring.
- Fool proof installation.
- Anchoring with stakes, Platypus anchors or Krinner screws.

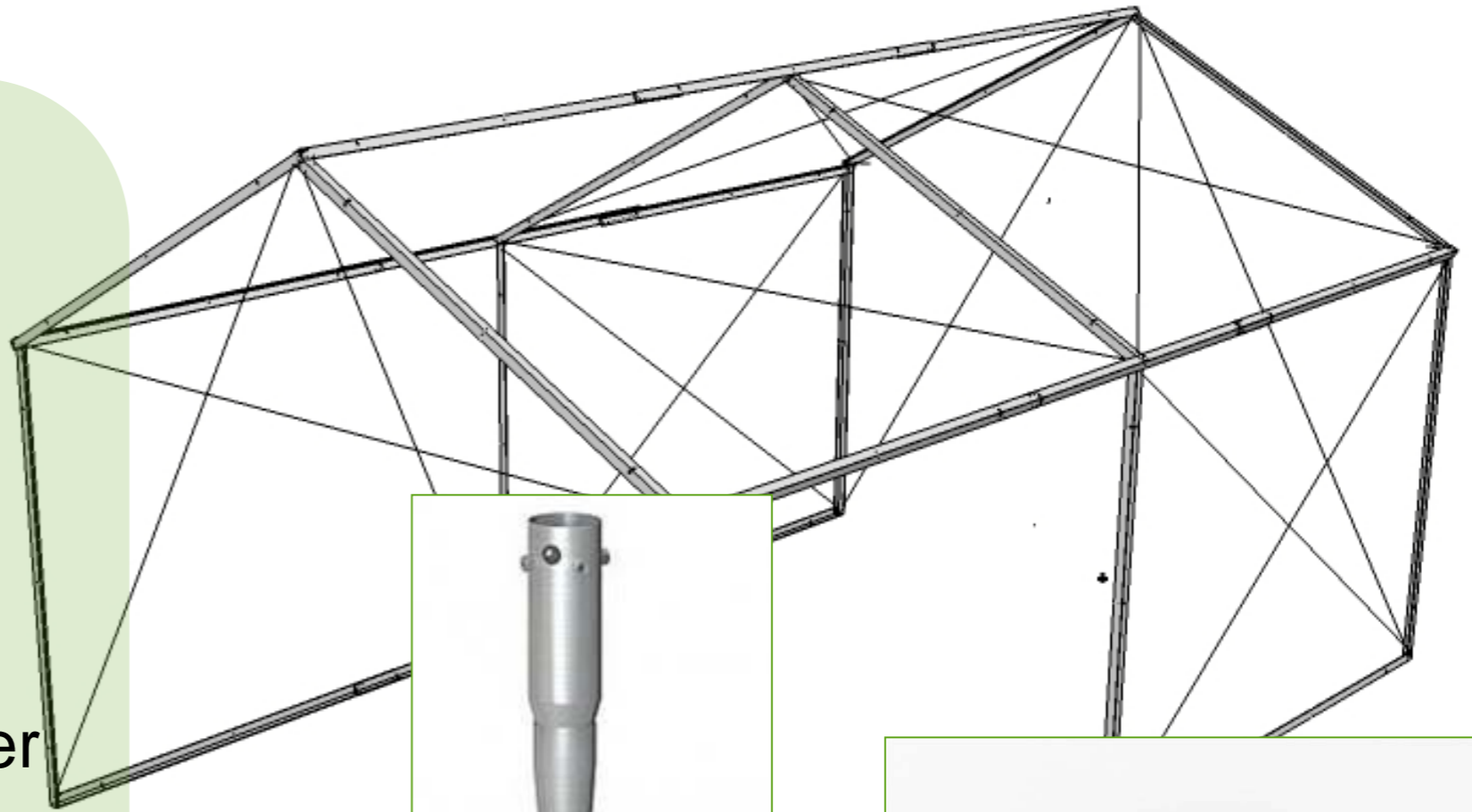

TT 200 Transitional Tent

Front panels

- Panels attached to frame with continuous rope.
- Possibility to tension panels.

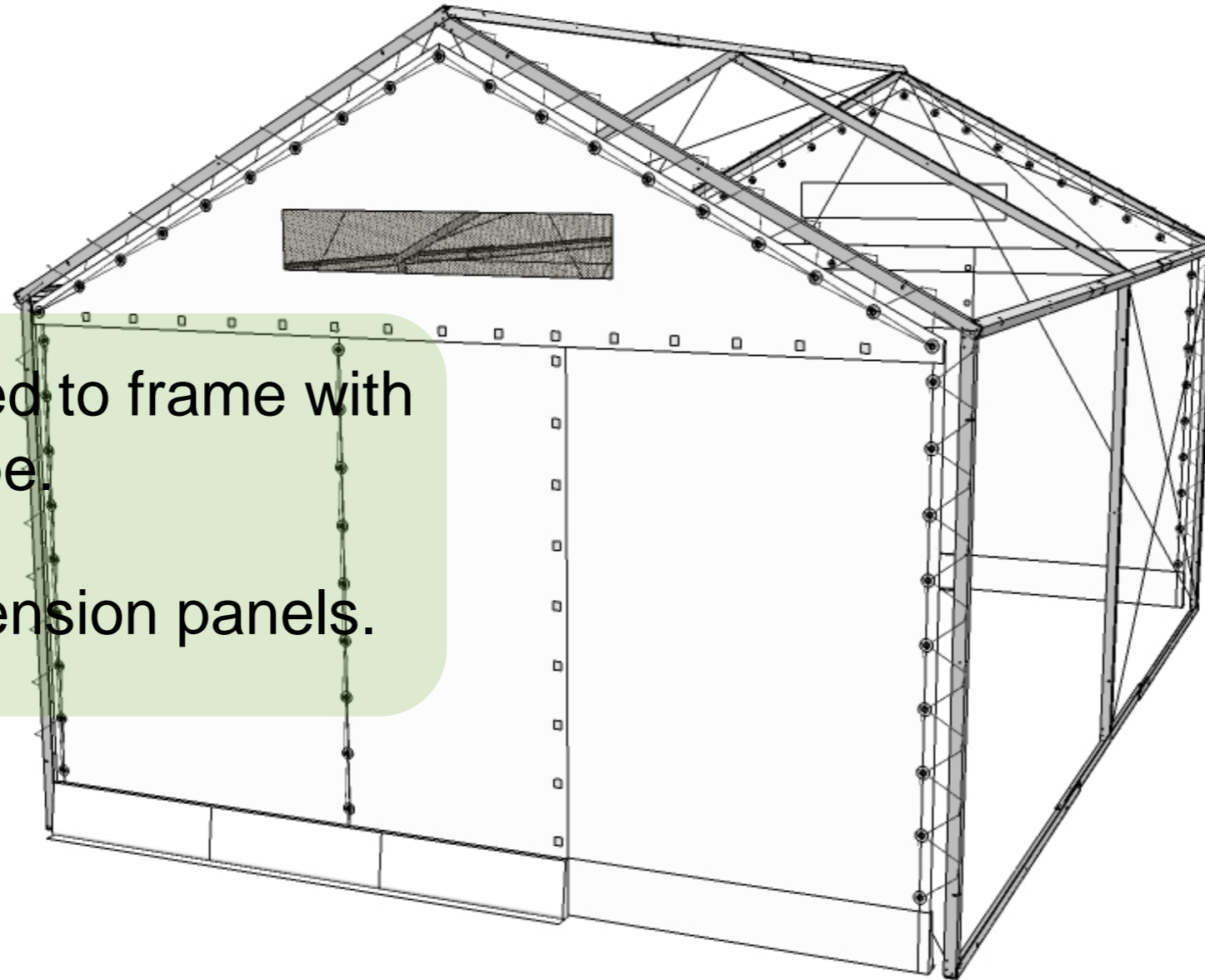

TT 200 Transitional Tent

Cover

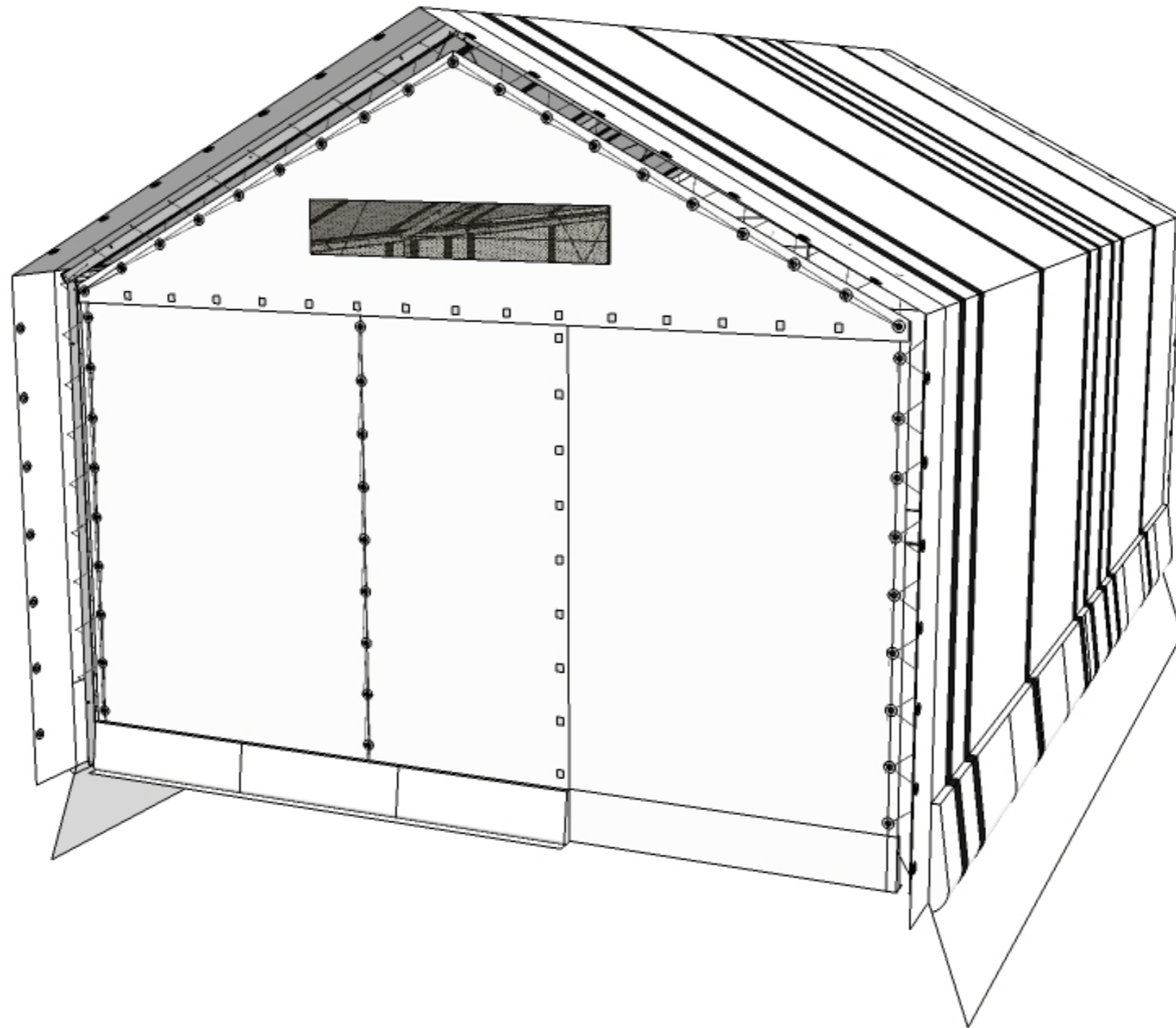

TT 200 Transitional Tent

Cover | horizontal tensioning

- Secure weather proof covering.
- Horizontal tensioning of cover.

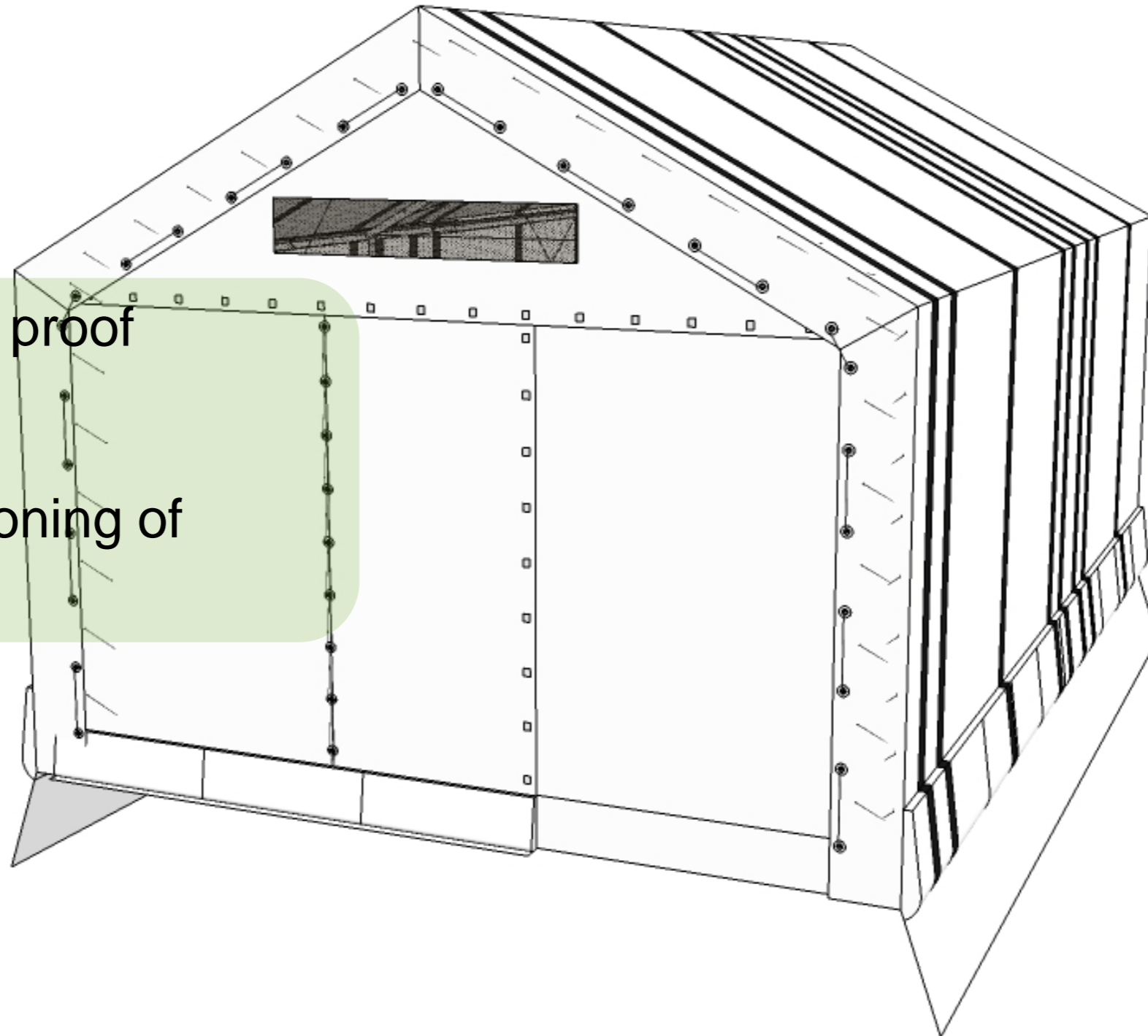

TT 200 Transitional Tent

Cover | vertical tensioning

- Vertical tensioning of cover to improve life span.
- Prevents ponding of rain and snow.

TT 200 Transitional Tent

Optional | Winterization kit

- Extra layer of insulating material between cover and frame.
- Extra frame parts provide added load bearing capacity.

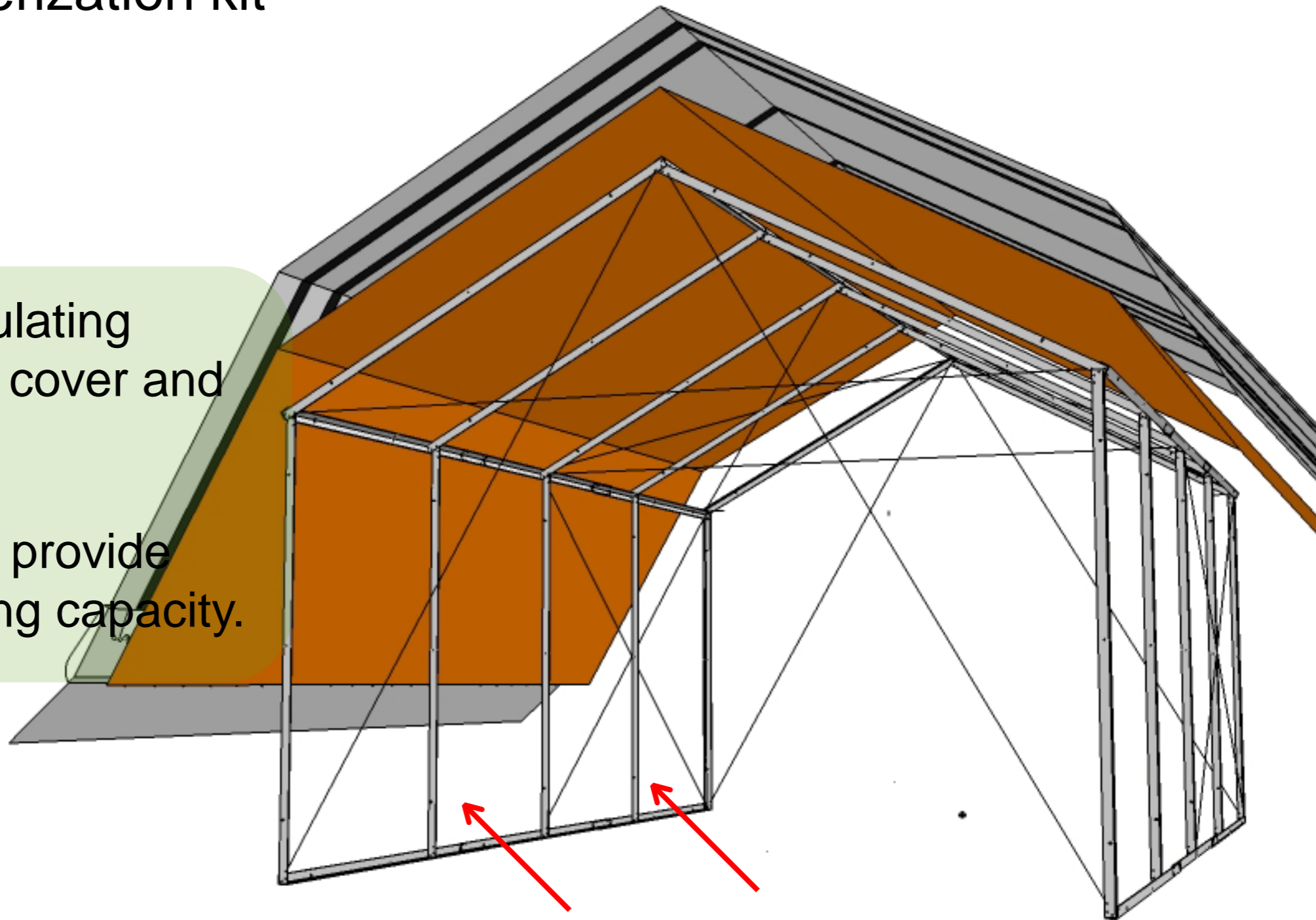

TT 200 Transitional Tent

Optional | Extra sleeping cabin

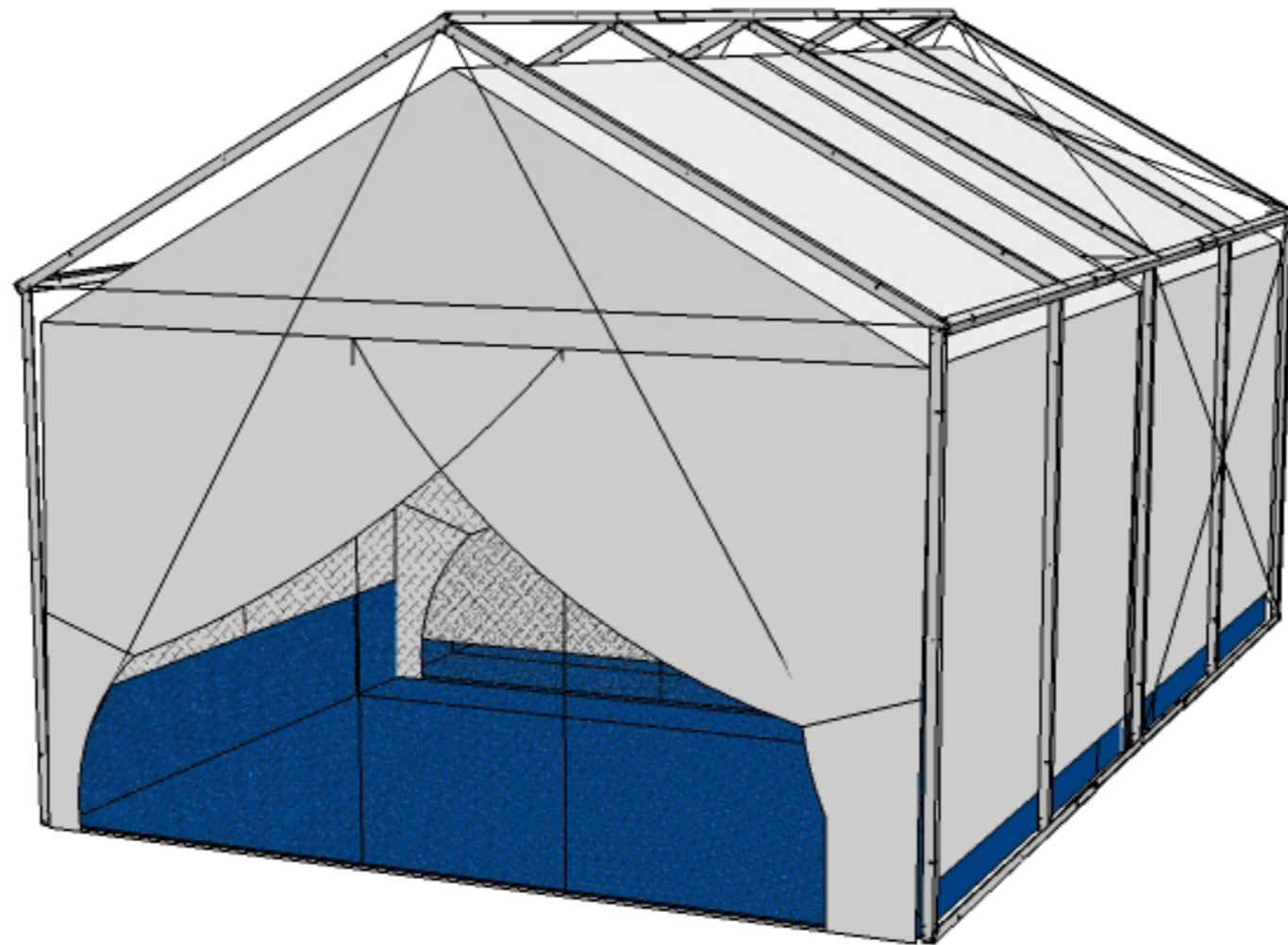

TT 200 Transitional Tent

Developments | Hard wall/roof panels

Pre-fabricated panels made of recycled plastics or impregnated cardboard.

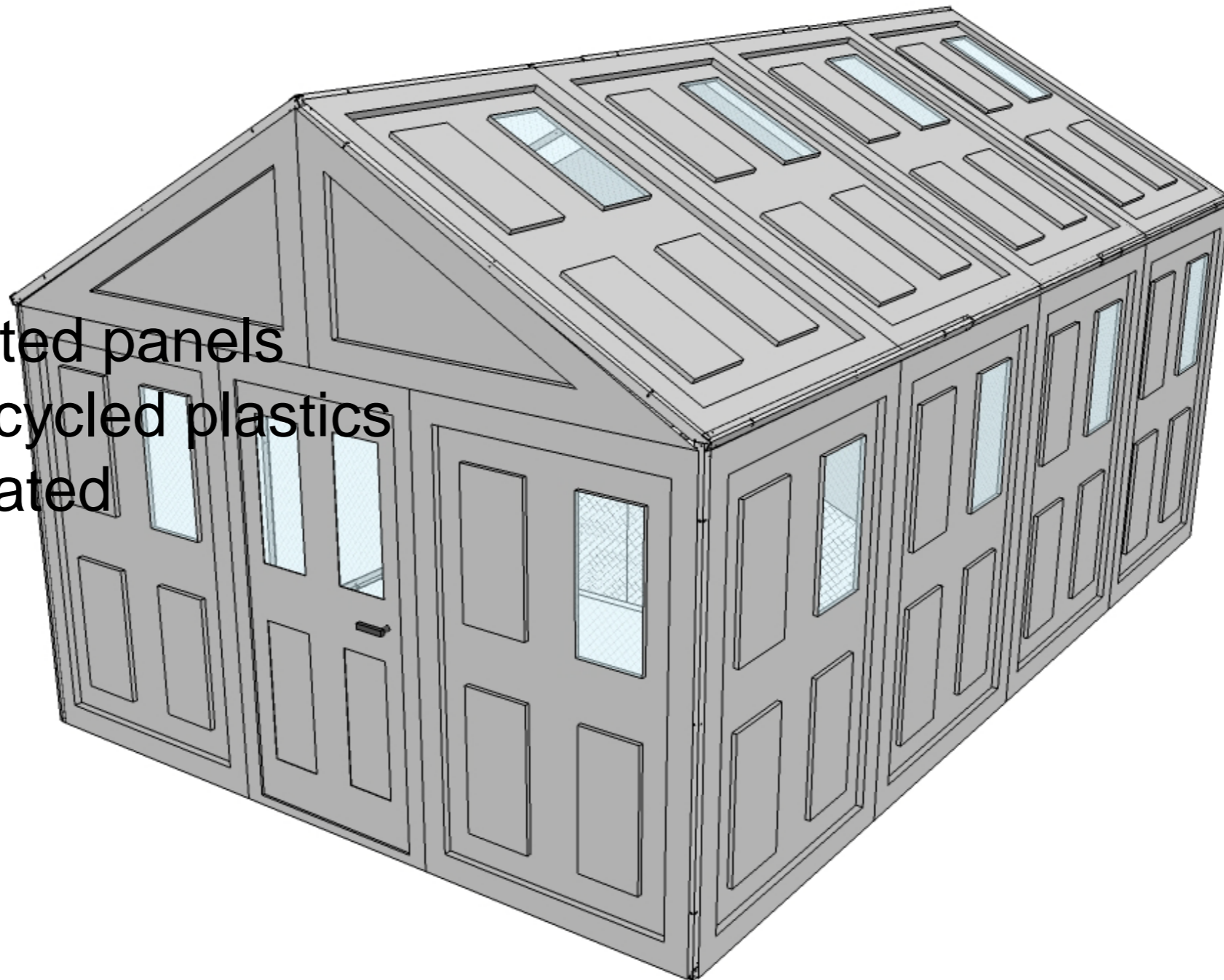

TT 200 Transitional Tent

Developments | Sun cover

- Enhanced mesh fabric to reflect direct sunlight and reduce heat built-up inside.

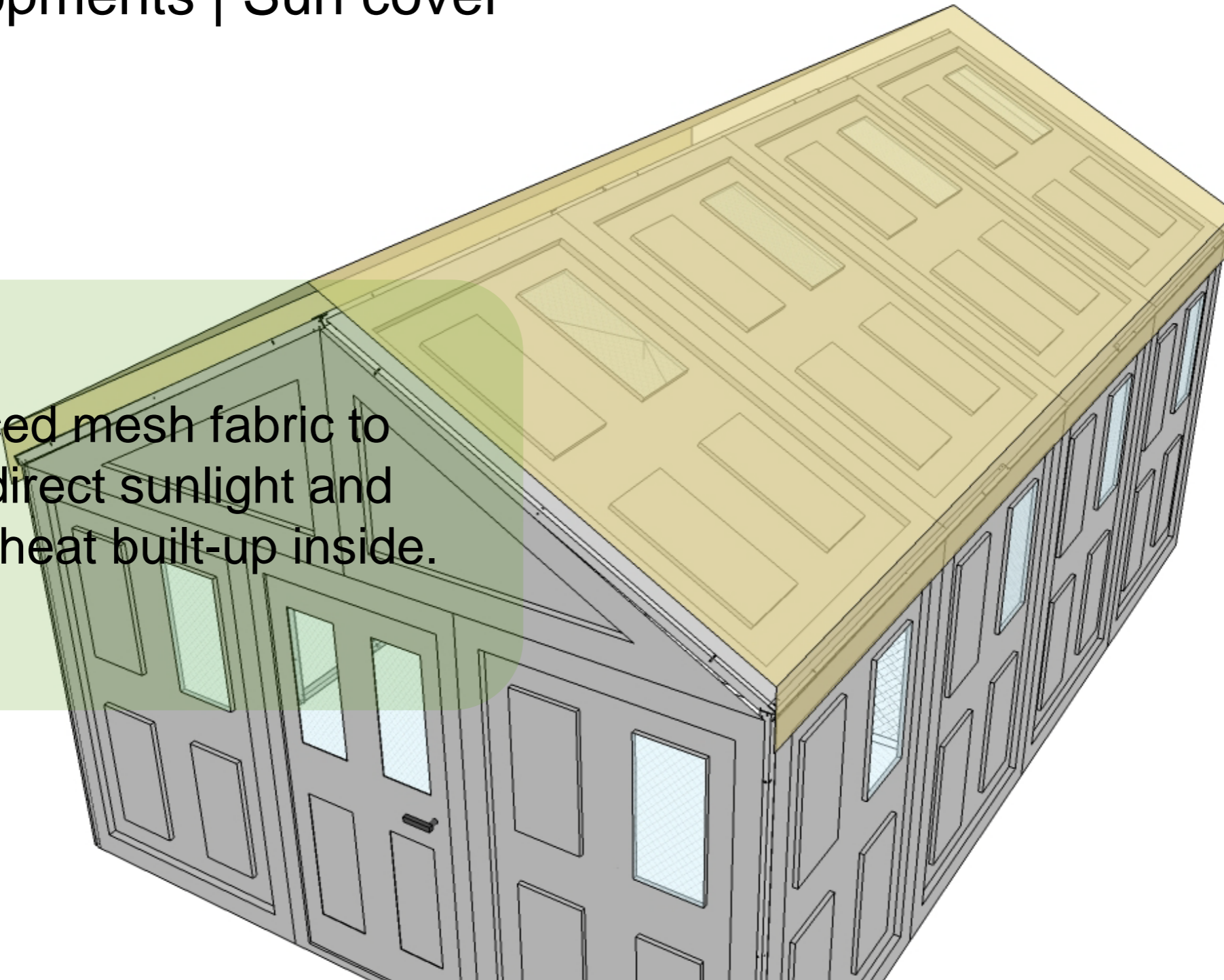

TT 200 Transitional Tent

Developments | Solar panels

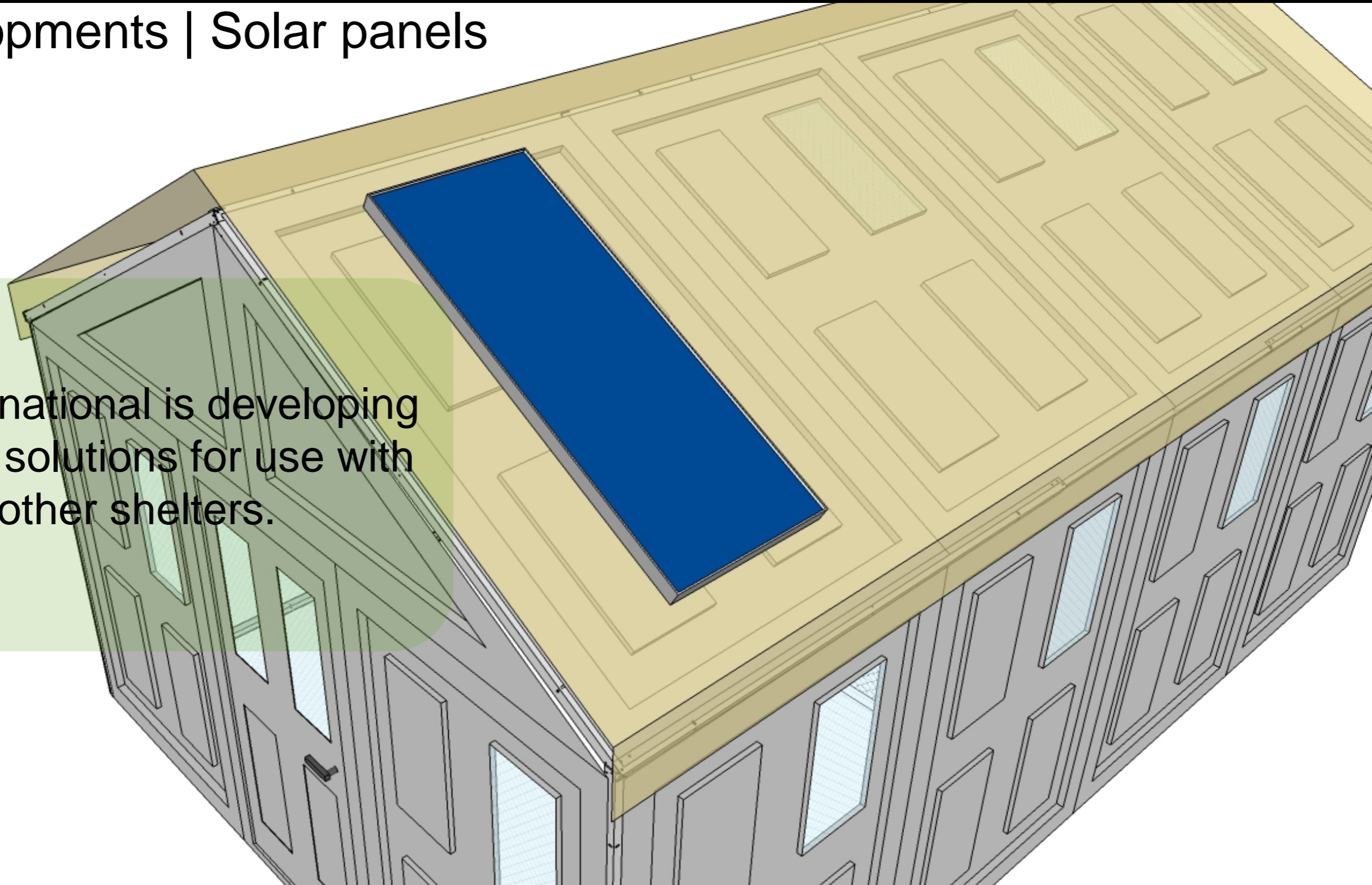

NRS International is developing new solar solutions for use with tents and other shelters.

Questions?



NRS International

THANK YOU!



NRS International